

ETITEC C T2 PV 550/20



Особенности

Артикул	002440429
Наименование	ETITEC C T2 PV 550/20
Вес	.302
Группа	Ограничители перенапряжения для PV
Тип	C
Количество полюсов	2
Стандарты iec vde	II / C
I _{max} (8/20) [кА]	40
Номинальное рабочее напряжение (V)	550 DC
RC	Нет
Серия	ETITEC C T2 PV Тип 2

Веб-страница продукта

Другая документация



[CE сертификат](#)
[Руководство по эксплуатации](#)
[Технические данные](#)

Габаритные размеры

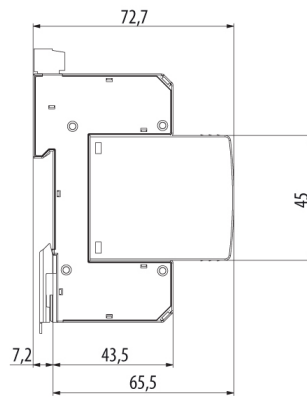
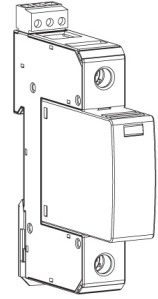
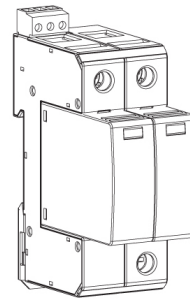
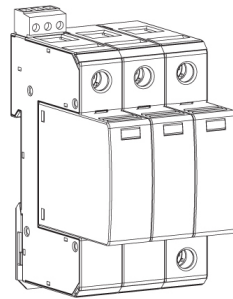
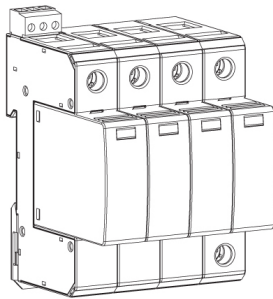
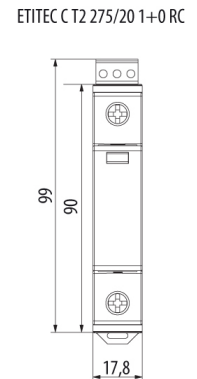
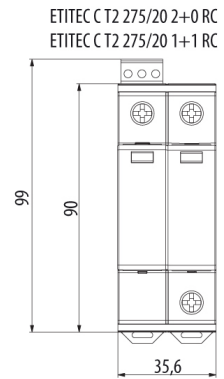
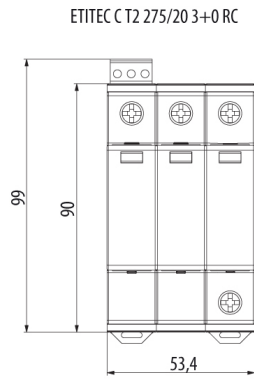
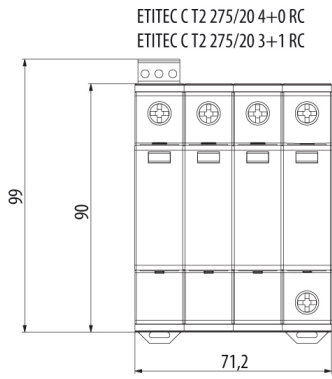

Обозначение/Подключение

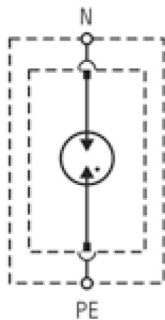

ETITEC CT2 G

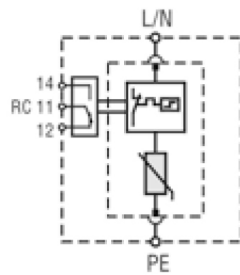

ETITEC CT2 1+0 RC

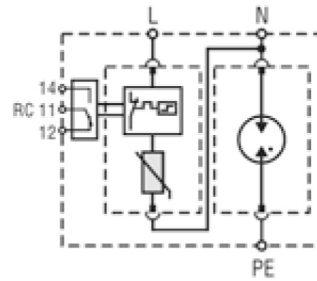

ETITEC CT2 1+1 RC

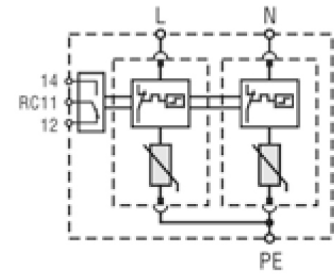

ETITEC CT2 2+0 RC

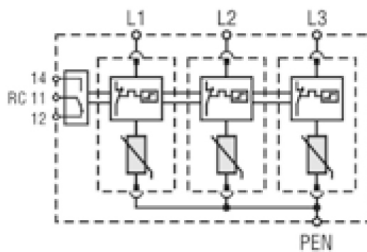

ETITEC CT2 3+0 RC

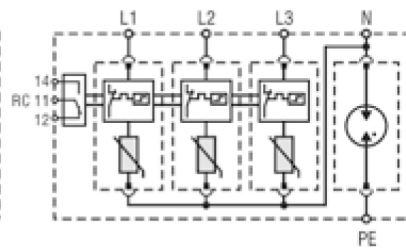

ETITEC CT2 3+1 RC

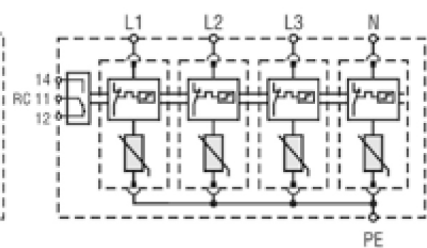

ETITEC CT2 4+0 RC